

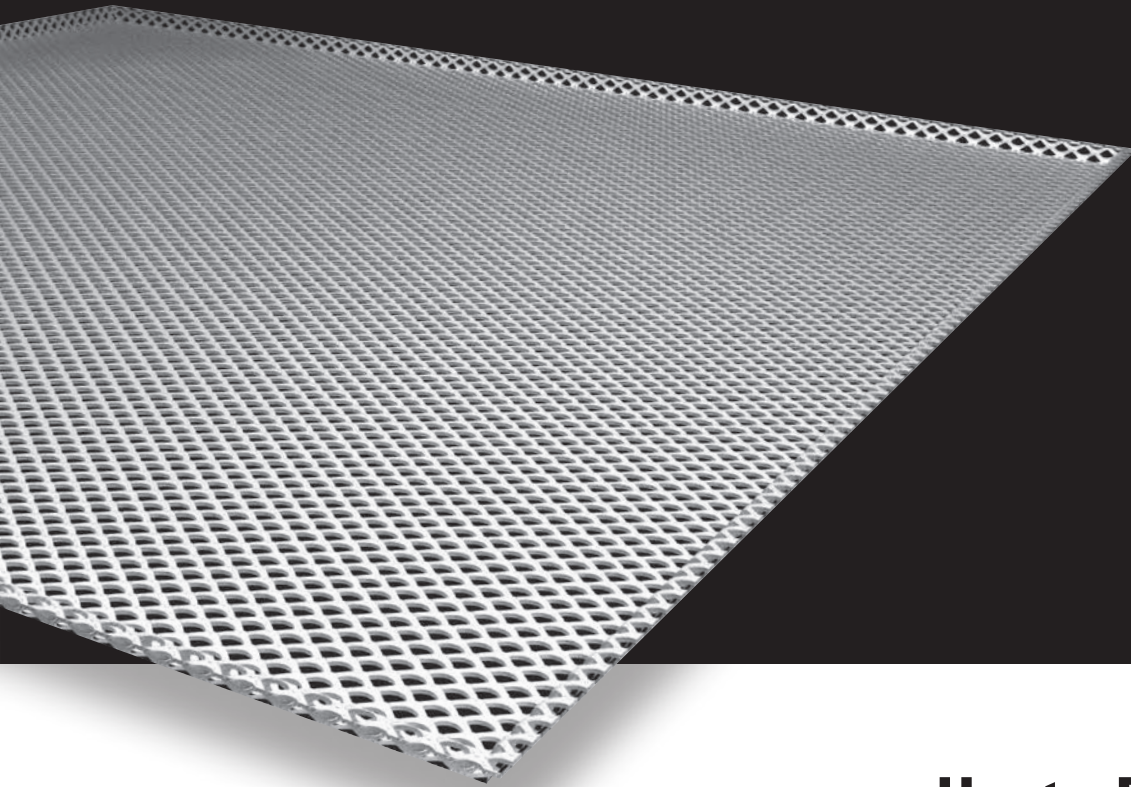

Stretch Metal Lay-In Bandraster

Stretch Metal from Hunter Douglas is a highly versatile **designer material** giving extra **visual effects** to ceilings. It is very easy to **customise ceilings** by varying the types of mesh, their arrangement, the lighting and the **colour**.



HunterDouglas 
Architectural

Lay-In Bandraster

TILES

Lay-In tiles can also be used installed on Bandraster system (50-100 mm). By pushing the tile upwards it is easy to gain access to the plenum without the use of tools.

Stretch Metal tiles are ideal for solutions where either a high level of acoustic absorption is required or where visual and physical transparency of the ceiling is requested. The systems are also ideal for solutions where regular access into the plenum is required. Because each tile has flanges that simply rest on the bandraster profiles, the access to the plenum is achieved by lifting the tile up into the area above the ceiling.

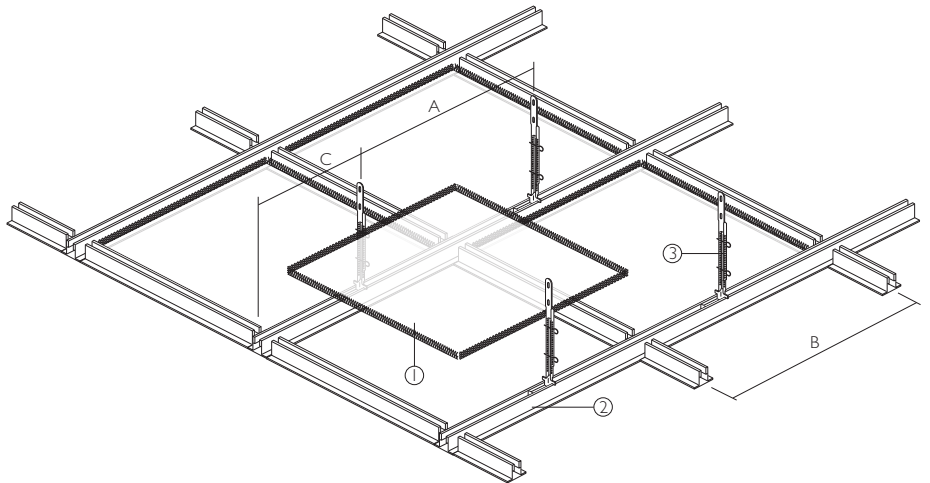

- 1 = Lay-In tile
- 2 = Bandraster (non HD)
- 3 = Hangers (non HD)

- A = 1200 mm (max.)
- B = Module
- C = 250 mm (max.)

DIMENSIONS

Lay-In/ Lay-On	50 mm	100 mm
Types	Bandraster	(Steel only/ welded edges only)
Grid	50 mm	100 mm
Reveal	0 mm	-
Module in mm:	625 x 625	1000 x 1000

OVERVIEW AVAILABLE EXECUTIONS / MAXIMUM DIMENSIONS

Mesh Type	% Open	50 mm bandraster		100 mm bandraster
		Lay-On	0 mm reveal	Lay-On
LD6	40	✓	✓	✓
LS8	54	✓	-	✓
LS10	57	✓	-	✓
LS12	66	flat sheets	-	flat sheets
LS16	46	flat sheets	-	flat sheets

MATERIAL REQUIREMENT PER M²

Components	Unit	Al/Fe	Fe Only
		625 x 625 mm	1000 x 1000 mm
Stretch Metal Lay-in	pcs	2.56	1.00
Grid profile (non-HD)	lm	3.20	2.00
Cross connector (non-HD)	pcs	5.12	2.00
Suspension (non-HD)	pcs	1.33	0.83

Acoustics

ACOUSTIC PERFORMANCE

Using acoustic pads on top of the Stretch Metal panels offers exceptional acoustic performance. The thickness of the pads can be chosen depending on the required acoustical values. The acoustic absorption value can reach α_w 1 with an acoustical pad of 85 mm.

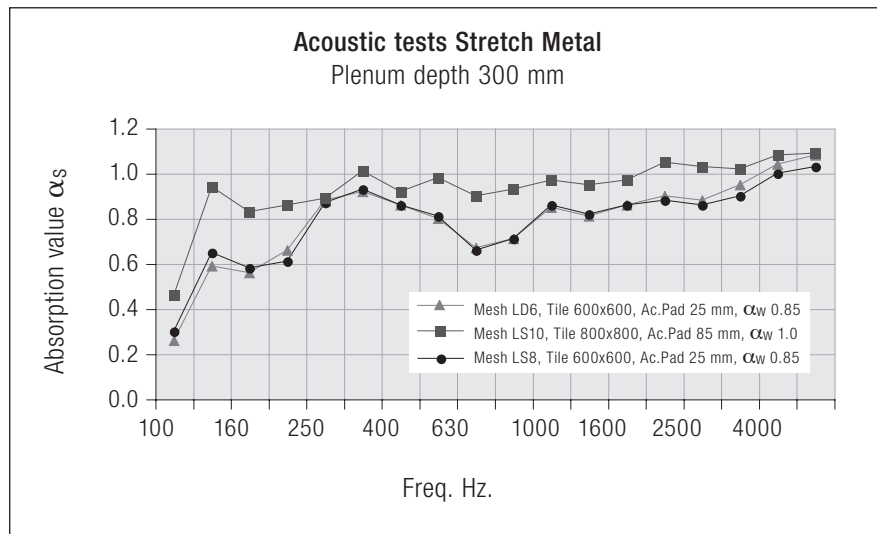

Material

TRANSPARENCY

The tiles can be made from various mesh types. This results in different optical effects if the natural or artificial light comes from the plenum. It is important to realise that stretch metal meshes do have a direction. Depending on viewing direction the mesh appears more or less open. This influences light coming through the material but also the visibility of installations in the plenum. The physical transparency can also be used for smoke extraction and sprinkler operation in case of fire.

FIRE BEHAVIOUR

HunterDouglas® metal ceilings are classified incombustible, and will therefore not contribute to fires. When ceilings need to protect the structural integrity of a building, HunterDouglas® ceilings offer a wide range of practical solutions with regards to fire resistance and fire stability. Further information is available on request.

COATING

Stretch Metal tiles are all powder coated materials. Durable powder coatings for exterior use are optionally available.

COLOUR RANGE

The standard colour range consists of RAL and NCS colours, including chrome. Other special colours are available on request.

QUALITY

Our focus on quality ensures the highest standard of production process, material, machinery and finished product. The superior durability of Hunter Douglas products translates into lower costs during the life cycle of the product due to longer life expectancy and lower maintenance costs. Our company processes are ISO 9001 certified.

INSTALLATION

It is necessary for all versions that qualitative suspension systems are used. The systems must be stable, aligned and leveled so that they comply with the requirements of the panels. For information on installation, refer to the applicable assembly instruction leaflets.

Mesh Types Tiles & Planks

Stretch Metal consists of metal sheet with diamond or square shaped holes. The stretch metal material is made with a tool that simultaneously cuts and stretches the sheets. As a result the mesh is created without any waste of material.

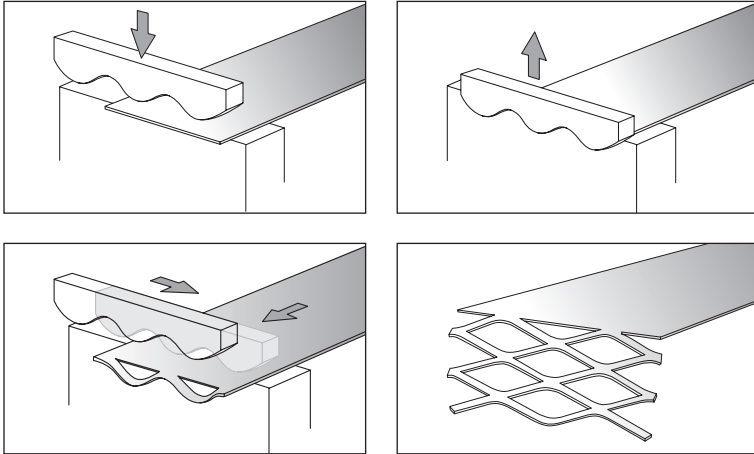

MESH TYPES

Standard

The standard mesh types are a square mesh (LS) or a diamond shaped mesh (LD) with a variation in openness of the mesh. The range starts with the smallest LS6/LD6 up to LS16. All mesh types are available in steel, with types LS8 and LS12 also available in aluminium.

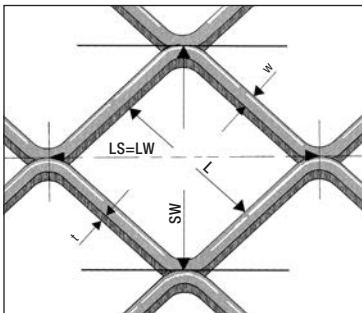

Key

- LS = LW
- LW = Long diagonal of mesh
- SW = Short diagonal of mesh
- W = Strand width
- t = Strand Thickness
- L = Inner size

Special

Several other mesh types are available on request, depending on technical requirements and availability. Hexagonal mesh, Round mesh and Ornamental meshes are examples of the possibilities.

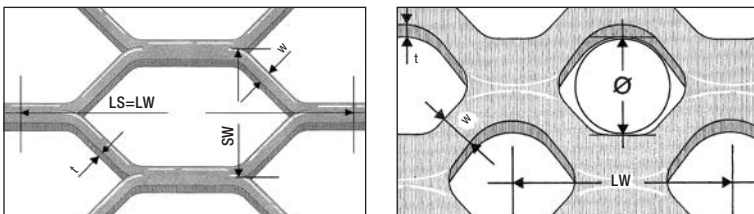

STANDARD MESH TYPES:

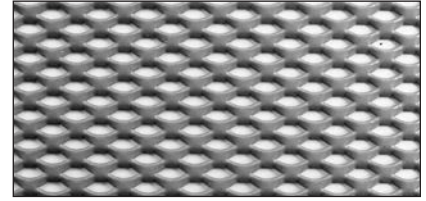

*LD6 (Fe) open area 40%, thickness 1.7 mm
dimensions: 6 x 3.5 - 1.1 x 0.8 - 1.6 kg/m²*

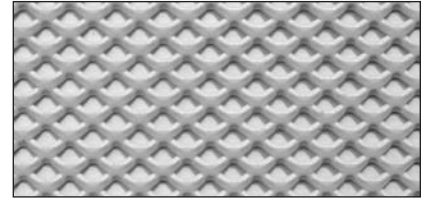

*LS6 (Fe) open area 36%, thickness 1.7 mm
dimensions: 6 x 4.5 - 1.2 x 1.0 - 1.3 kg/m²*

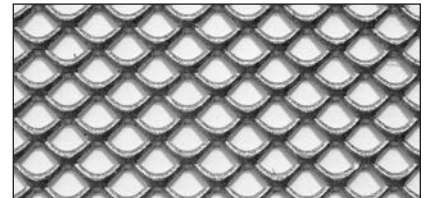

*LS8 (Fe+Al) open area 54%, thickness 1.9 mm
dimensions: 8 x 6.0 - 1.2 x 1.0 - 1.7 kg/m²*



*LS10 (Fe) open area 57%, thickness 2.0 mm
dimensions: 10 x 7.0 - 1.5 x 1.0 - 1.3 kg/m²*

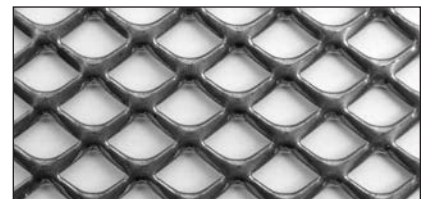

*LS12 (Fe+Al) open area 66%, thickness 2.0 mm
dimensions: 12 x 9.5 - 1.6 x 1.0 - 1.7 kg/m²*

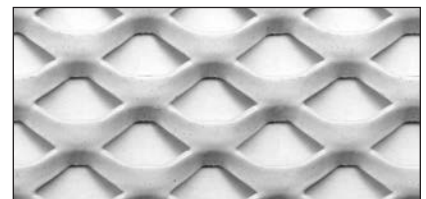

*LS16 (Fe) open area 46%, thickness 2.0 mm
dimensions: 16 x 11.0 - 3.0 x 2.0 - 2.0 kg/m²*

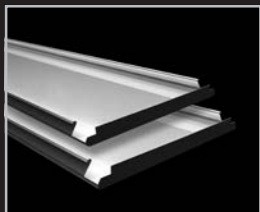

Wide Panel

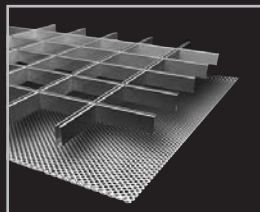

Cell | Stretch metal

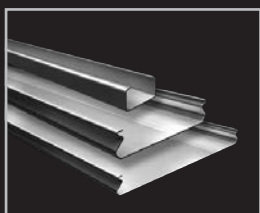

Linear

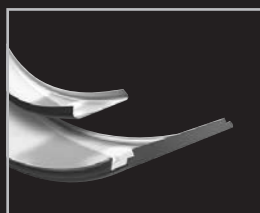

Curved



Screen

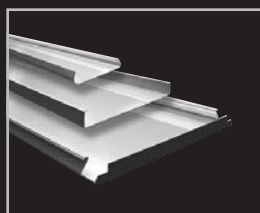

Exterior

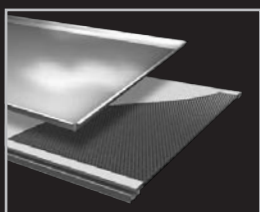

Tiles | XLnt panel

- Belgium
- Bulgaria
- Croatia / Slovenia
- Czech Republic
- Denmark
- France
- Germany
- Greece
- Hungary
- Italy
- The Netherlands
- Norway
- Poland
- Portugal
- Romania
- Russia
- Serbia
- Slovakia
- Spain
- Sweden
- Switzerland
- Turkey
- United Kingdom
- Africa
- Middle East

- Asia
- Australia
- Latin America
- North America



Hunter Douglas Architectural

Piekstraat 2
P.O. Box 5072 - 3008 AB Rotterdam
The Netherlands
Tel. +31 (0)10 - 486 99 11
Fax +31 (0)10 - 484 79 10
www.hunterdouglasarchitectural.eu

© Registered trademark - a HunterDouglas® product Pats. & Pats. Pend. -
Technical data subject to change without notice. © Copyright Hunter Douglas 2018.
No rights can be derived from copy, text pertaining to illustrations or samples.
Subject to changes in materials, parts, compositions, designs, versions, colours etc.,
even without notice. MX800S00