

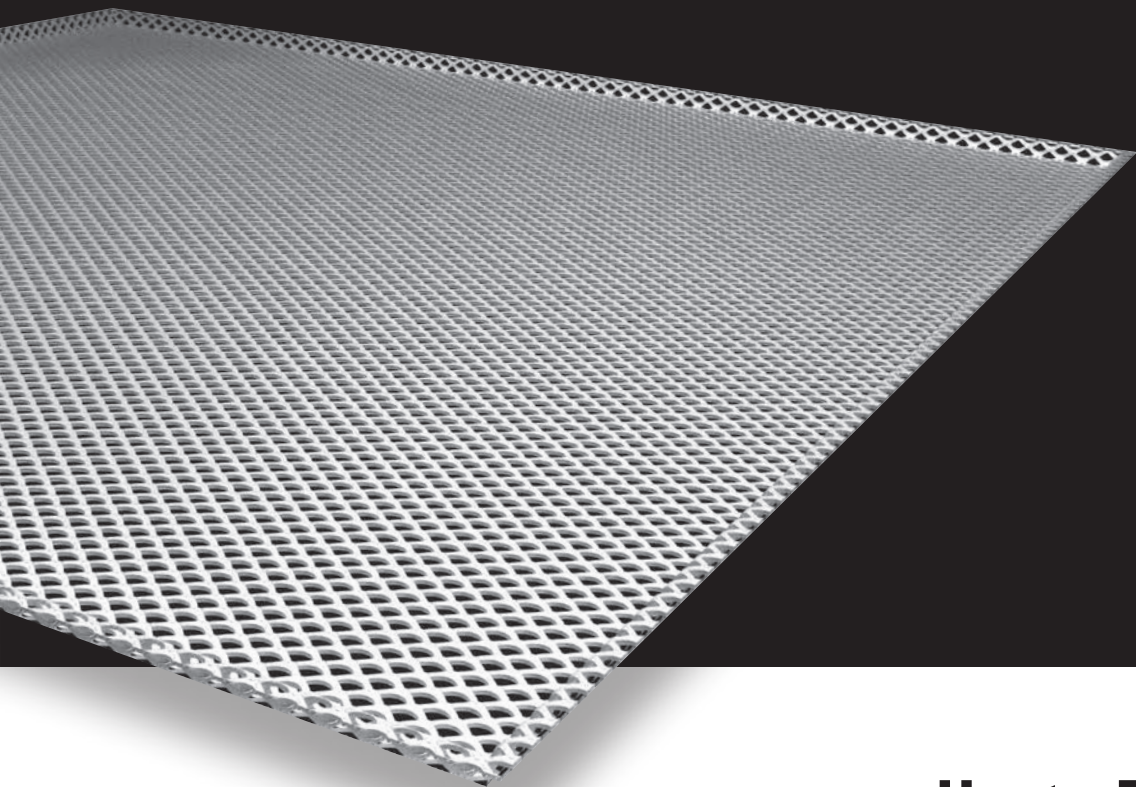

Stretch Metal Lay-On Corridor

Stretch Metal from Hunter Douglas is a highly versatile **designer material** giving extra **visual effects** to ceilings. It is very easy to **customise ceilings** by varying the types of mesh, their arrangement, the lighting and the **colour**.



HunterDouglas 
Architectural

Lay-On Corridor

PLANKS

Stretch Metal planks designed to be installed on conventional wall angle profiles. The planks can be lifted and easily removed without the aid of tools. The panels are recyclable, lightweight and strong.

SUSPENSION

The panels are supported at their ends by wall angle profiles (2 & 3). The panels have straight upstands at the panel ends. Depending on panel length the panel sides are re-inforced with spot-welded steel angle profiles.

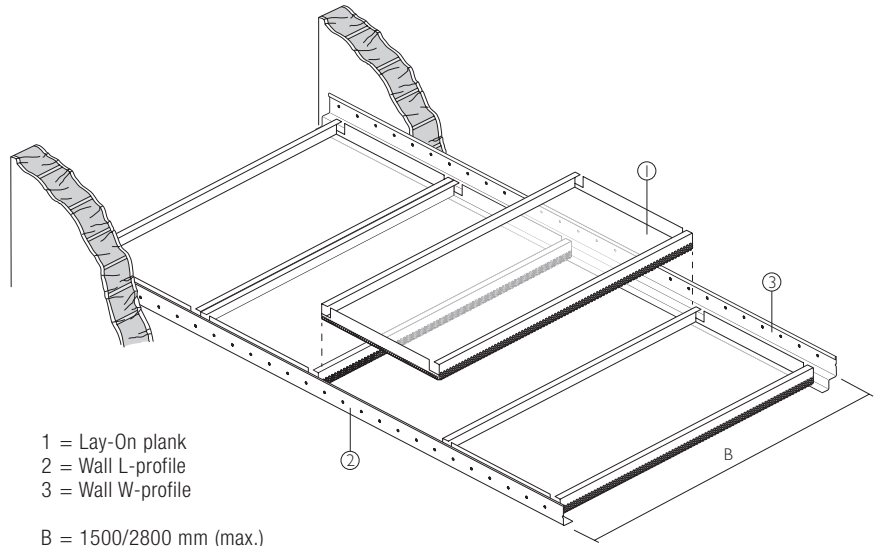

CONSTRUCTION DETAILS

Steel L or W shaped edge profiles can be used as perimeters.

BASE MATERIAL

Stretch Metal planks are available in steel. The Stretch Metal plank (Version-I) can be re-inforced with a welded support profile on the inside (Version-II).

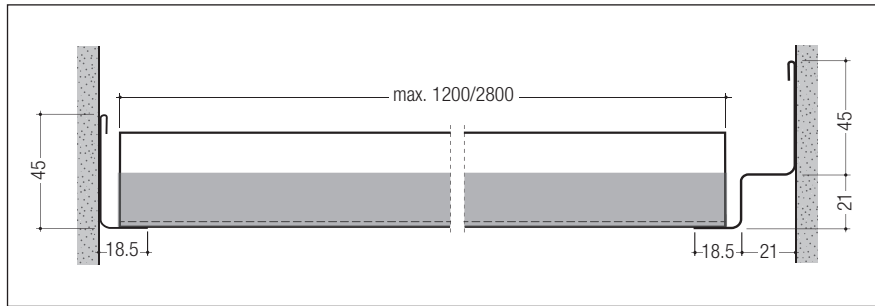

Version-I: Stretch Metal

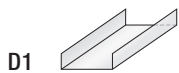

Version-II: Stretch Metal with welded support profile

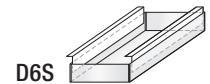
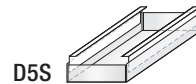
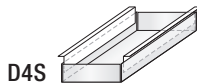
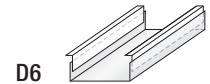
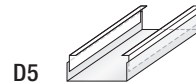
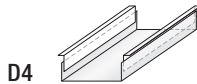

OVERVIEW AVAILABLE EXECUTIONS / MAXIMUM DIMENSIONS

Mesh Type	% Open	Version-I, no reinforcement: D1	Version-II, with reinforcement: D4-D6/D4S-D6S
LS6	40	500 x 1200 mm	600 x 2800 mm
LD6	40	500 x 1200 mm	600 x 2800 mm
LS8	54	500 x 1200 mm	600 x 2800 mm
LS10	57	500 x 1200 mm	600 x 2800 mm
LS12	66	500 x 1200 mm	600 x 2800 mm
LS16	46	500 x 1200 mm	600 x 2800 mm

Remark: due to differences in deflection, one shall never mix Version-I and Version-II panels in one area

MATERIAL REQUIREMENT PER M²

Components	Unit	Fe	
		Version-I, max. 500 x 1200 mm	Version-II, max. 600 x 2800 mm
Stretch Metal Lay-on	pcs	1.67	0.59
Edge trim profile L/W	lm	1.67	0.71

Acoustics

ACOUSTIC PERFORMANCE

Using acoustic pads on top of the Stretch Metal panels offers exceptional acoustic performance. The thickness of the pads can be chosen depending on the required acoustical values. The acoustic absorption value can reach α_w 1 with an acoustical pad of 85 mm.

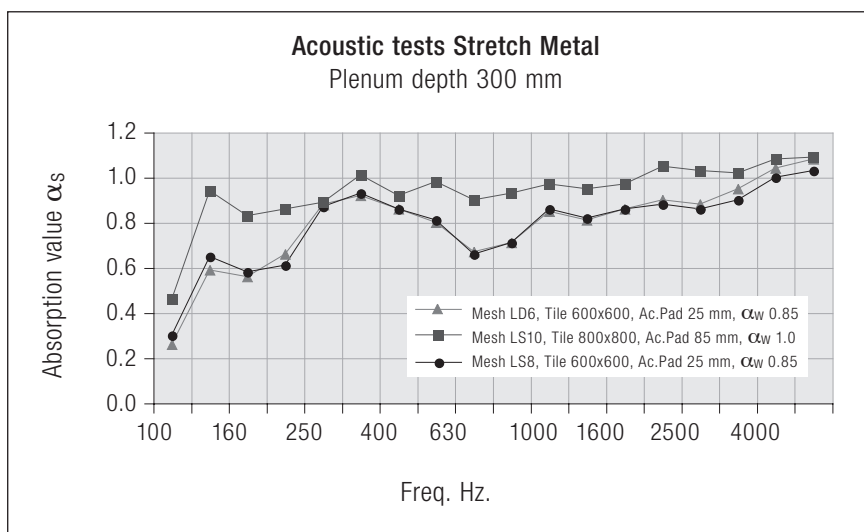

Material

TRANSPARENCY

The tiles can be made from various mesh types. This results in different optical effects if the natural or artificial light comes from the plenum. It is important to realise that stretch metal meshes do have a direction. Depending on viewing direction the mesh appears more or less open. This influences light coming through the material but also the visibility of installations in the plenum. The physical transparency can also be used for smoke extraction and sprinkler operation in case of fire.

FIRE BEHAVIOUR

HunterDouglas® metal ceilings are classified incombustible, and will therefore not contribute to fires. When ceilings need to protect the structural integrity of a building, HunterDouglas® ceilings offer a wide range of practical solutions with regards to fire resistance and fire stability. Further information is available on request.

COATING

Stretch Metal tiles are all powder coated materials. Durable powder coatings for exterior use are optionally available.

COLOUR RANGE

The standard colour range consists of RAL and NCS colours, including chrome. Other special colours are available on request.

QUALITY

Our focus on quality ensures the highest standard of production process, material, machinery and finished product. The superior durability of Hunter Douglas products translates into lower costs during the life cycle of the product due to longer life expectancy and lower maintenance costs. Our company processes are ISO 9001 certified.

INSTALLATION

It is necessary for all versions that qualitative suspension systems are used. The systems must be stable, aligned and leveled so that they comply with the requirements of the panels. For information on installation, refer to the applicable assembly instruction leaflets.

Mesh Types Tiles & Planks

Stretch Metal consists of metal sheet with diamond or square shaped holes. The stretch metal material is made with a tool that simultaneously cuts and stretches the sheets. As a result the mesh is created without any waste of material.

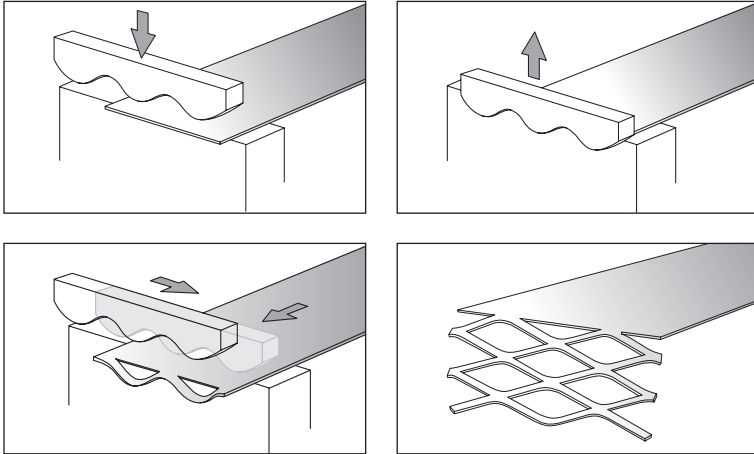

MESH TYPES

Standard

The standard mesh types are a square mesh (LS) or a diamond shaped mesh (LD) with a variation in openness of the mesh. The range starts with the smallest LS6/LD6 up to LS16. All mesh types are available in steel, with types LS8 and LS12 also available in aluminium.

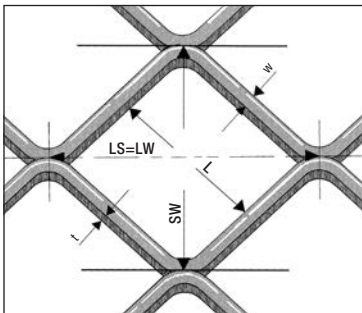

Key

- LS = LW
- LW = Long diagonal of mesh
- SW = Short diagonal of mesh
- W = Strand width
- t = Strand Thickness
- L = Inner size

Special

Several other mesh types are available on request, depending on technical requirements and availability. Hexagonal mesh, Round mesh and Ornamental meshes are examples of the possibilities.

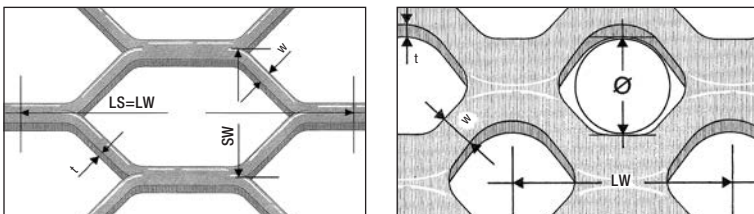

STANDARD MESH TYPES:

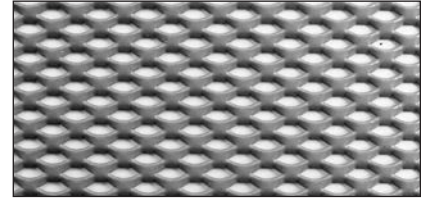

LD6 (Fe) open area 40%, thickness 1.7 mm
dimensions: 6 x 3.5 - 1.1 x 0.8 - 1.6 kg/m²

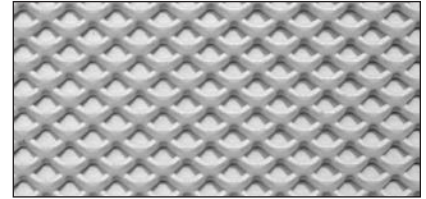

LS6 (Fe) open area 36%, thickness 1.7 mm
dimensions: 6 x 4.5 - 1.2 x 1.0 - 1.3 kg/m²



LS8 (Fe+Al) open area 54%, thickness 1.9 mm
dimensions: 8 x 6.0 - 1.2 x 1.0 - 1.7 kg/m²



LS10 (Fe) open area 57%, thickness 2.0 mm
dimensions: 10 x 7.0 - 1.5 x 1.0 - 1.3 kg/m²

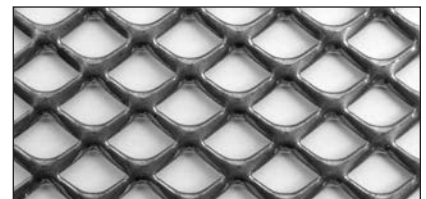

LS12 (Fe+Al) open area 66%, thickness 2.0 mm
dimensions: 12 x 9.5 - 1.6 x 1.0 - 1.7 kg/m²

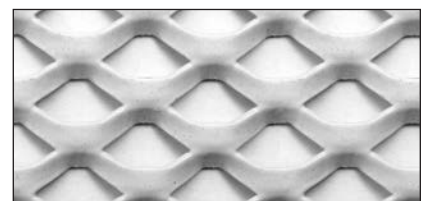

LS16 (Fe) open area 46%, thickness 2.0 mm
dimensions: 16 x 11.0 - 3.0 x 2.0 - 2.0 kg/m²

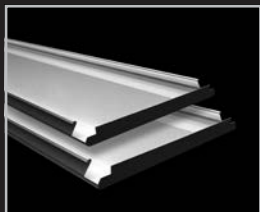

Wide Panel

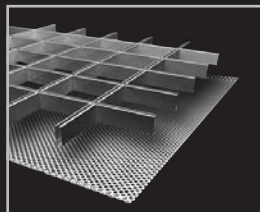

Cell | Stretch metal

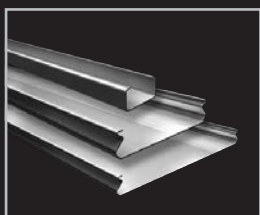

Linear

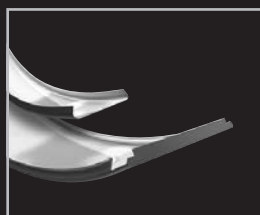

Curved

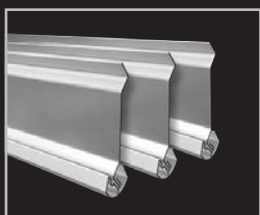

Screen

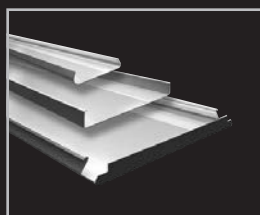

Exterior

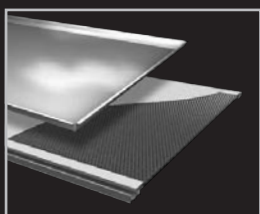

Tiles | XLnt panel

- Belgium
- Bulgaria
- Croatia / Slovenia
- Czech Republic
- Denmark
- France
- Germany
- Greece
- Hungary
- Italy
- The Netherlands
- Norway
- Poland
- Portugal
- Romania
- Russia
- Serbia
- Slovakia
- Spain
- Sweden
- Switzerland
- Turkey
- United Kingdom
- Africa
- Middle East

- Asia
- Australia
- Latin America
- North America

