

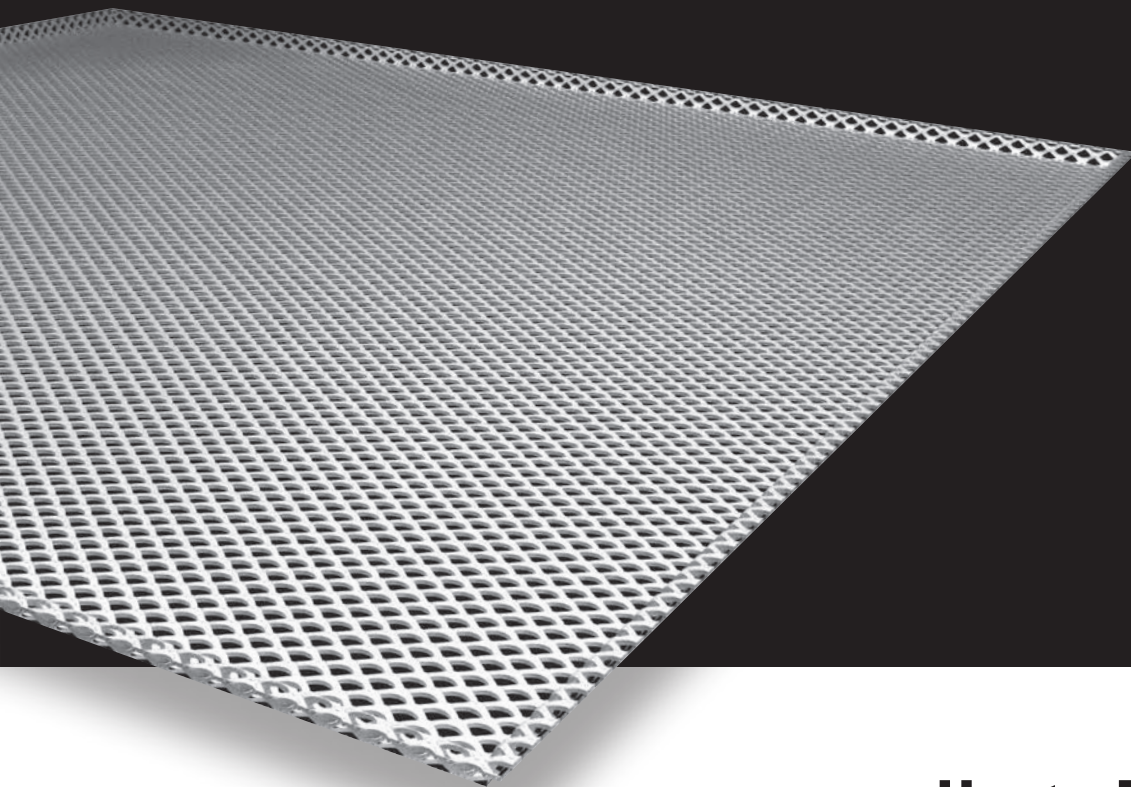

Stretch Metal Lay-In/Lay-On

Stretch Metal from Hunter Douglas is a highly versatile designer material giving extra visual effects to ceilings. It is very easy to customise ceilings by varying the types of mesh, their arrangement, the lighting and the colour.



HunterDouglas 
Architectural

Lay-In / Lay-On

TILES

Lay-In/Lay-On tiles are designed to be installed on conventional T-grid systems (T-profiles widths 15 and 24 mm). Stretch Metal tiles on T-profiles enhance the modular design pattern. By using wider grids or deeper recesses more distinctive patterns are created. They are ideal for situations where regular maintenance or service is required to the installations in the ceiling plenum. By pushing the tile upwards into the plenum and moving it sideways it is easy to gain access to the plenum without the use of tools. Before selecting this system care should be taken that there is enough space to lift the tiles upwards. Another benefit is that accessories like light fixtures and airconditioning grills are easily integrated in the system.

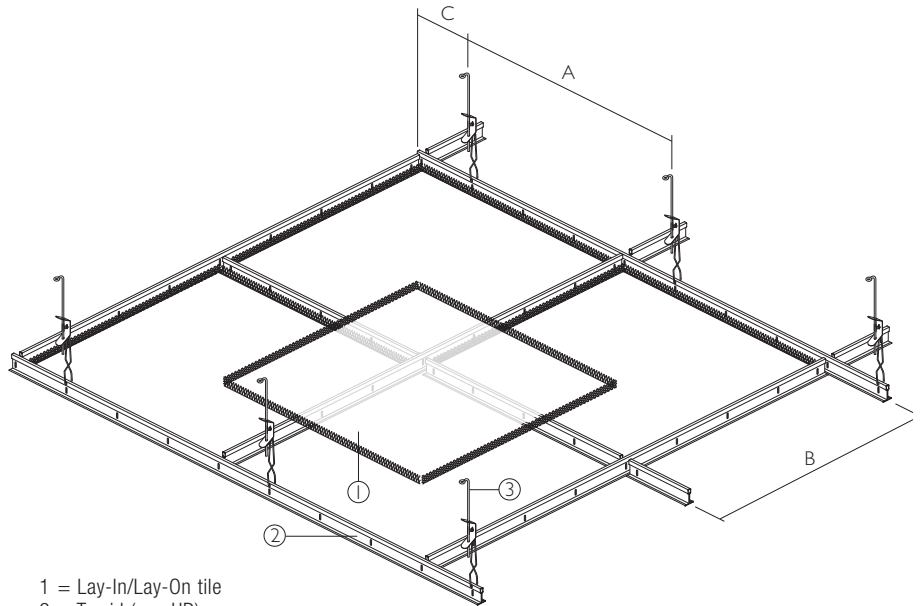

- 1 = Lay-In/Lay-On tile
- 2 = T-grid (non HD)
- 3 = Hangers (non HD)

- A = 1200 mm (max.)
- B = Module
- C = 250 mm (max.)

DIMENSIONS

Lay-In / Lay on	Lay-In			Lay-On		
	15/8	24/8	24/0	15/8	15	24
Types	-	-	-	15 mm Channel Grid*	-	-
Grid	15 mm	24 mm	24 mm	15 mm	15 mm	24 mm
Reveal	8 mm	8 mm	0 mm	-	0 mm	0 mm
Module in mm:	600 x 600	600 x 600	600 x 600	600 x 600	600 x 600	600 x 600

*(T-profile with integrated fixing possibility)

OVERVIEW AVAILABLE EXECUTIONS / MAXIMUM DIMENSIONS

Mesh Type	% Open	T15 Profile			T24 Profile		
		Lay-On	8 mm Reveal	Channel Grid	Lay-On	0 mm Reveal	8 mm Reveal
LD6	40	✓	✓	✓	✓	✓	✓
LS8	54	✓	✓	✓	✓	-	✓
LS10	57	✓	✓	✓	✓	-	✓
LS12	66	✓	-	-	✓	-	-
LS16	46	✓*	-	-	✓	-	-

*Press-braked

MATERIAL REQUIREMENT PER M²

Components	Unit	Al/Fe 600 x 600 mm
Stretch Metal Lay-in/ Lay-on	pcs	2.78
Grid profile (non-HD)	lm	3.33
Suspension (non-HD)	pcs	0.69

Acoustics

ACOUSTIC PERFORMANCE

Using acoustic pads on top of the Stretch Metal panels offers exceptional acoustic performance. The thickness of the pads can be chosen depending on the required acoustical values. The acoustic absorption value can reach α_w 1 with an acoustical pad of 85 mm.

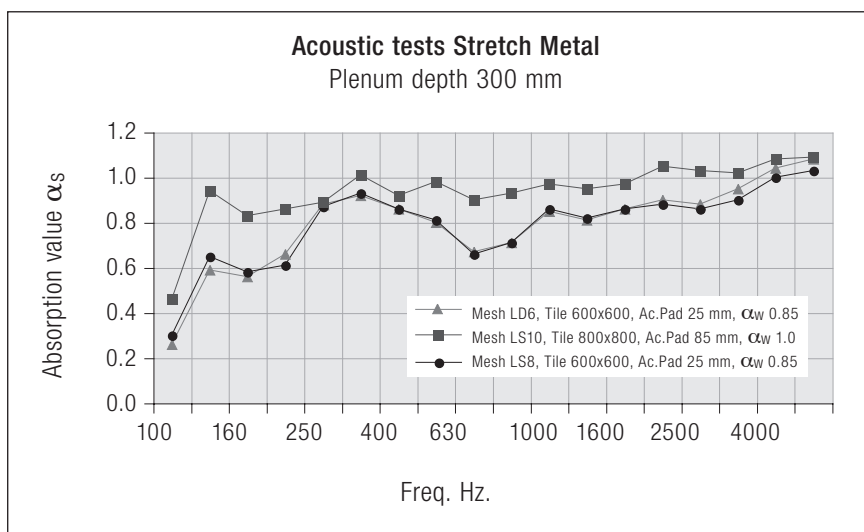

Material

TRANSPARENCY

The tiles can be made from various mesh types. This results in different optical effects if the natural or artificial light comes from the plenum. It is important to realise that stretch metal meshes do have a direction. Depending on viewing direction the mesh appears more or less open. This influences light coming through the material but also the visibility of installations in the plenum. The physical transparency can also be used for smoke extraction and sprinkler operation in case of fire.

FIRE BEHAVIOUR

HunterDouglas® metal ceilings are classified incombustible, and will therefore not contribute to fires. When ceilings need to protect the structural integrity of a building, HunterDouglas® ceilings offer a wide range of practical solutions with regards to fire resistance and fire stability. Further information is available on request.

COATING

Stretch Metal tiles are all powder coated materials. Durable powder coatings for exterior use are optionally available.

COLOUR RANGE

The standard colour range consists of RAL and NCS colours, including chrome. Other special colours are available on request.

QUALITY

Our focus on quality ensures the highest standard of production process, material, machinery and finished product. The superior durability of Hunter Douglas products translates into lower costs during the life cycle of the product due to longer life expectancy and lower maintenance costs. Our company processes are ISO 9001 certified.

INSTALLATION

It is necessary for all versions that qualitative suspension systems are used. The systems must be stable, aligned and leveled so that they comply with the requirements of the panels. For information on installation, refer to the applicable assembly instruction leaflets.

Mesh Types Tiles & Planks

Stretch Metal consists of metal sheet with diamond or square shaped holes. The stretch metal material is made with a tool that simultaneously cuts and stretches the sheets. As a result the mesh is created without any waste of material.

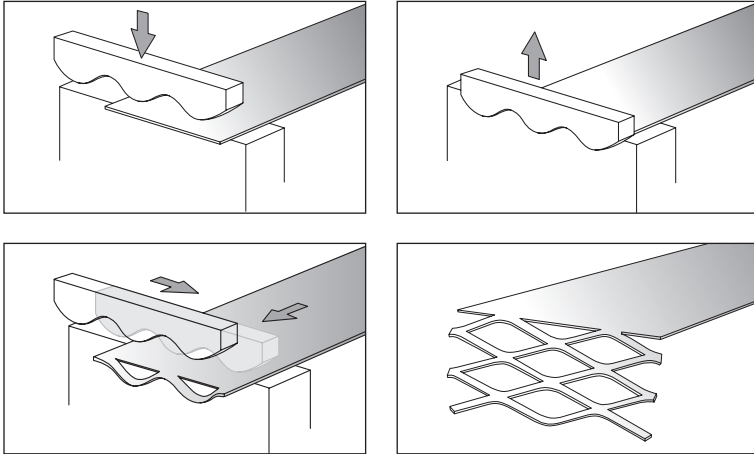

MESH TYPES

Standard

The standard mesh types are a square mesh (LS) or a diamond shaped mesh (LD) with a variation in openness of the mesh. The range starts with the smallest LS6/LD6 up to LS16. All mesh types are available in steel, with types LS8 and LS12 also available in aluminium.

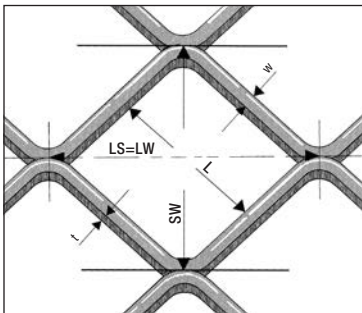

Key

- LS = LW
- LW = Long diagonal of mesh
- SW = Short diagonal of mesh
- W = Strand width
- t = Strand Thickness
- L = Inner size

Special

Several other mesh types are available on request, depending on technical requirements and availability. Hexagonal mesh, Round mesh and Ornamental meshes are examples of the possibilities.

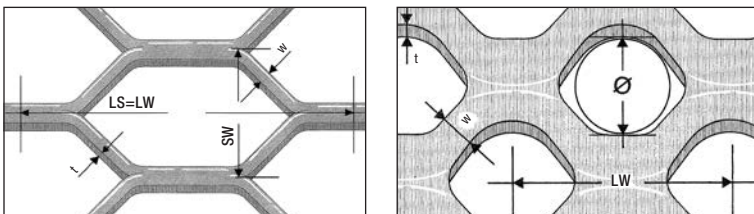

STANDARD MESH TYPES:

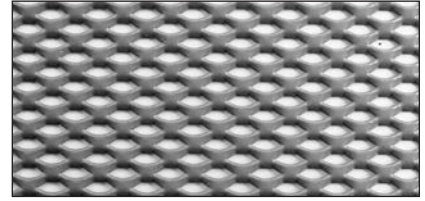

*LD6 (Fe) open area 40%, thickness 1.7 mm
dimensions: 6 x 3.5 - 1.1 x 0.8 - 1.6 kg/m²*

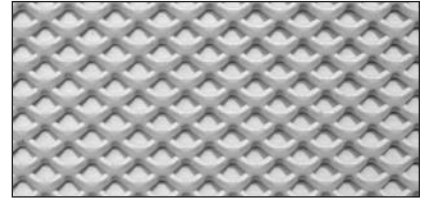

*LS6 (Fe) open area 36%, thickness 1.7 mm
dimensions: 6 x 4.5 - 1.2 x 1.0 - 1.3 kg/m²*



*LS8 (Fe+Al) open area 54%, thickness 1.9 mm
dimensions: 8 x 6.0 - 1.2 x 1.0 - 1.7 kg/m²*



*LS10 (Fe) open area 57%, thickness 2.0 mm
dimensions: 10 x 7.0 - 1.5 x 1.0 - 1.3 kg/m²*

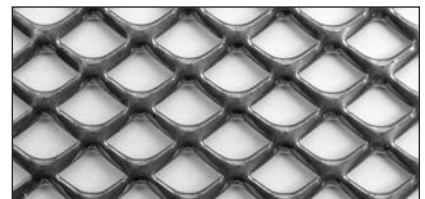

*LS12 (Fe+Al) open area 66%, thickness 2.0 mm
dimensions: 12 x 9.5 - 1.6 x 1.0 - 1.7 kg/m²*

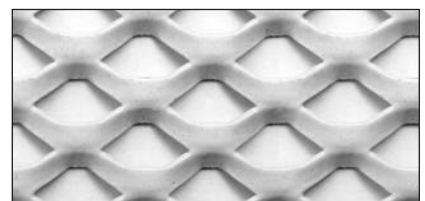

*LS16 (Fe) open area 46%, thickness 2.0 mm
dimensions: 16 x 11.0 - 3.0 x 2.0 - 2.0 kg/m²*

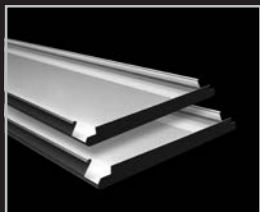

Wide Panel

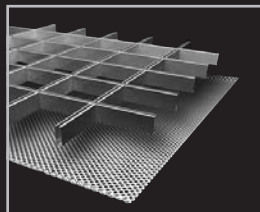

Cell | Stretch metal

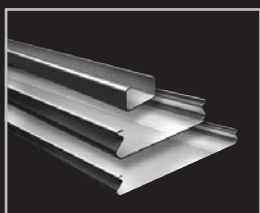

Linear

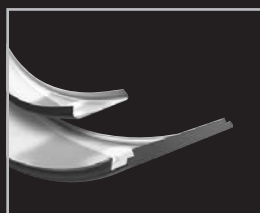

Curved

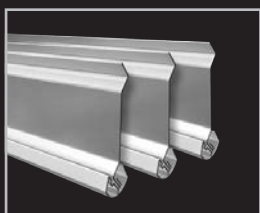

Screen

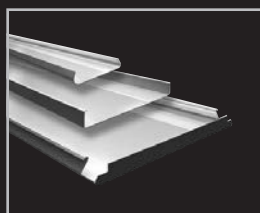

Exterior

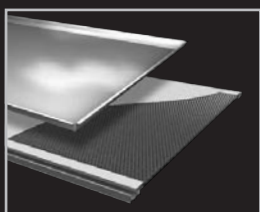

Tiles | XLnt panel

- Belgium
- Bulgaria
- Croatia / Slovenia
- Czech Republic
- Denmark
- France
- Germany
- Greece
- Hungary
- Italy
- The Netherlands
- Norway
- Poland
- Portugal
- Romania
- Russia
- Serbia
- Slovakia
- Spain
- Sweden
- Switzerland
- Turkey
- United Kingdom
- Africa
- Middle East

- Asia
- Australia
- Latin America
- North America



Hunter Douglas Architectural

Piekstraat 2
P.O. Box 5072 - 3008 AB Rotterdam
The Netherlands
Tel. +31 (0)10 - 486 99 11
Fax +31 (0)10 - 484 79 10
www.hunterdouglasarchitectural.eu

© Registered trademark - a HunterDouglas® product Pats. & Pats. Pend. -
Technical data subject to change without notice. © Copyright Hunter Douglas 2018.
No rights can be derived from copy, text pertaining to illustrations or samples.
Subject to changes in materials, parts, compositions, designs, versions, colours etc.,
even without notice. MX800S00